

Farm 1

0116001

DREWNO - FARM



Material specification:

Construction Material	made of glued wood, surface-impregnated, square cross-section 95 x 95 mm
Additional Elements Handrails	galvanized black steel, powder-coated or stainless steel
Platforms	plywood or HPL Panels
Foundation	buried in the ground to a specified depth and concreted with at least B-20 class concrete or bolted to a concrete base
Sheets	HDPE sheets with milled drawings
Slides	made of stainless steel, tubular, tube-shaped, or with HDPE plate sides

Due to continuous improvement of technical solutions by Freekids, the presented drawings, including colours and dimensions, may differ slightly from currently manufactured devices.



FreeKids s.c. A. Gąsiorek, Z.Andruszewski
Trzęsowice 32, 55-106 Zawonia

tel./fax: +48 71 312 72 50, +48 724 654 898
e-mail: biuro@freekids.pl www.freekids.pl

rev. 001/2026

Farm 1

0116001

DREWNO - FARM

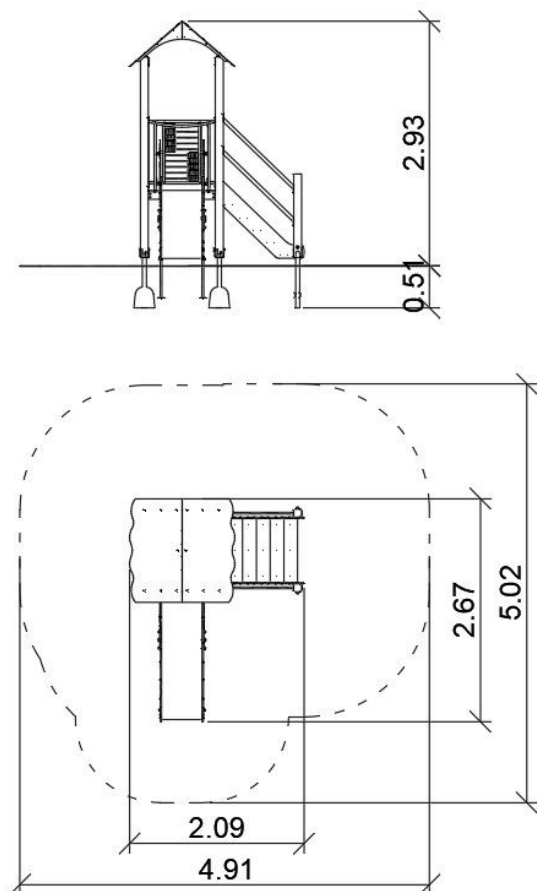

DEVICE DATA:

Device dimension	2,09 x 2,67 x 2,93 m
Zone dimension	4,91 x 5,02 m
Fall height	0,90 m
Safety zone area	19,9 m ²
User age	3-12
Number of users	6
Material	Drewno
Low fall height	tak
Compliance with standards	PN-EN 1176

Due to continuous improvement of technical solutions by Freekids, the presented drawings, including colours and dimensions, may differ slightly from currently manufactured devices.