



Inclusive

Mini Florini 4

0190004

METAL - MINI FLORINI



Material specification:

Construction Material	galvanized steel coated with powder paint for durability and corrosion resistance or made of stainless steel
Additional Elements Handrails	galvanized black steel, powder-coated or stainless steel
Platforms	plywood or HPL Panels
Foundation	buried in the ground to a specified depth and concreted with at least B-20 class concrete or bolted to a concrete base
Sheets	HDPE sheets with milled drawings or Solid polycarbonate sheets, clear or tinted
Slides	made of stainless steel, tubular, tube-shaped, or with HDPE plate sides

Due to continuous improvement of technical solutions by Freekids, the presented drawings, including colours and dimensions, may differ slightly from currently manufactured devices.



FreeKids s.c. A. Gąsiorek, Z. Andruszewski
Trzęsowice 32, 55-106 Zawonia

tel./fax: +48 71 312 72 50, +48 724 654 898
e-mail: biuro@freekids.pl www.freekids.pl

rev. 001/2026

Mini Florini 4

0190004

METAL - MINI FLORINI

DEVICE DATA:

Device dimension	2,96 x 2,07 x 2,70 m
Zone dimension	5,40 x 4,30 m
Fall height	0,56 m
Safety zone area	17,7 m ²
User age	2-6
Number of users	14
Material	Metal
Low fall height	tak
Compliance with standards	PN-EN 1176

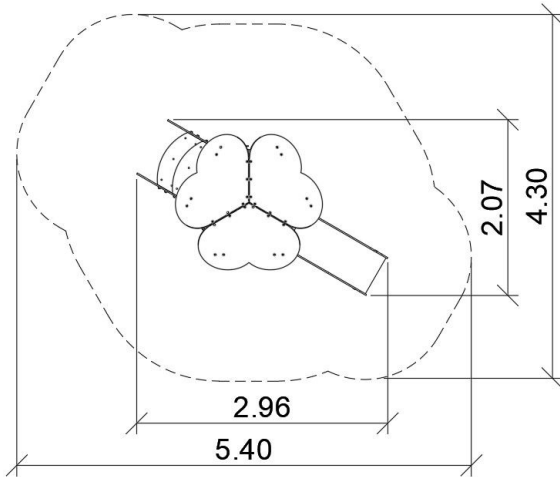

Due to continuous improvement of technical solutions by Freekids, the presented drawings, including colours and dimensions, may differ slightly from currently manufactured devices.



FreeKids s.c. A. Gąsiorek, Z.Andruszewski
Trzęsowice 32, 55-106 Zawonia

tel./fax: +48 71 312 72 50, +48 724 654 898
e-mail: biuro@freekids.pl www.freekids.pl

rev. 001/2026